

To FHWA, BOT, DNCR, DOT and Littleton Selectboard,

In response to FHWA's email of July 20, 2022:

"Kris,

Thank you for the information. Through recent contact with DNCR staff, we understand that the Town of Littleton has temporarily allowed ATVs to use Industrial Road this season to bypass the TE-funded trail segment, and that they will likely re-evaluate after this year to determine if it should be continued, noting that no major safety issues or concerns have been raised so far. We also have heard that signage has been changed, but the gate remains open for safety reasons.

Leigh"

One selectboard member voted against opening Industrial Park Rd. to OHRVs because of safety concerns.

I have communicated to the Selectboard the recommendation by OHRV manufacturers and other groups, that OHRVs not be used on dirt or paved roads.

"Two national lobbying groups that represent manufacturers of off-highway vehicles said in position papers recently forwarded to local officials that they were opposed to on-highway use of OHVs and all-terrain vehicles. Additionally, a federal commission on consumer safety published guidance in 2016 and again in 2018 that Americans should not drive the vehicles on paved, public roads."

<https://www.moabtimes.com/articles/utv-maker-groups-want-them-off-paved-roads-due-to-safety/>

BOT's statement that "Trails Bureau does not believe the town will allow OHRV use on Industrial Park Rd. because of heavy semi-truck usage and vehicle speeds.

It simply would not be safe" is (one would hope) an expression of safety concerns.

It is not credible that BOT is unable to safely gate this trail to prevent motorized use. The OHRV detour to Industrial Park Rd., as one heads from Lisbon to Littleton is before the gate.

Below, OHRV clubs, aided by BOT, have designed and placed many gates to block OHRV traffic:

Proposed Southern Connector Trail – Nash Stream Road and West Side Road Trail Intersection

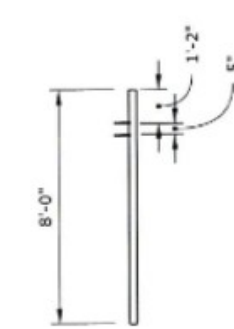
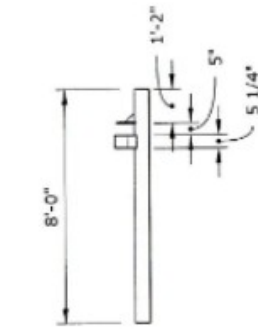
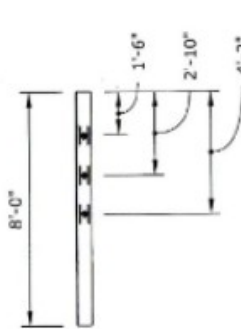
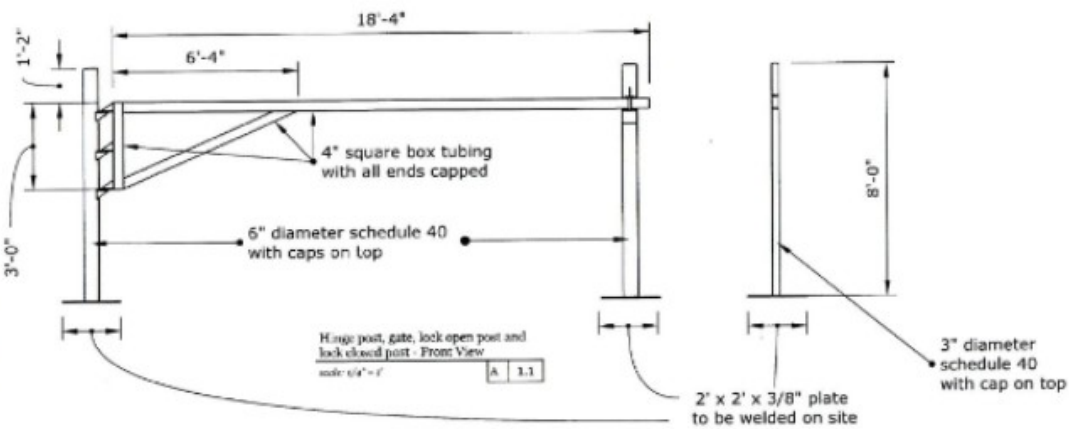
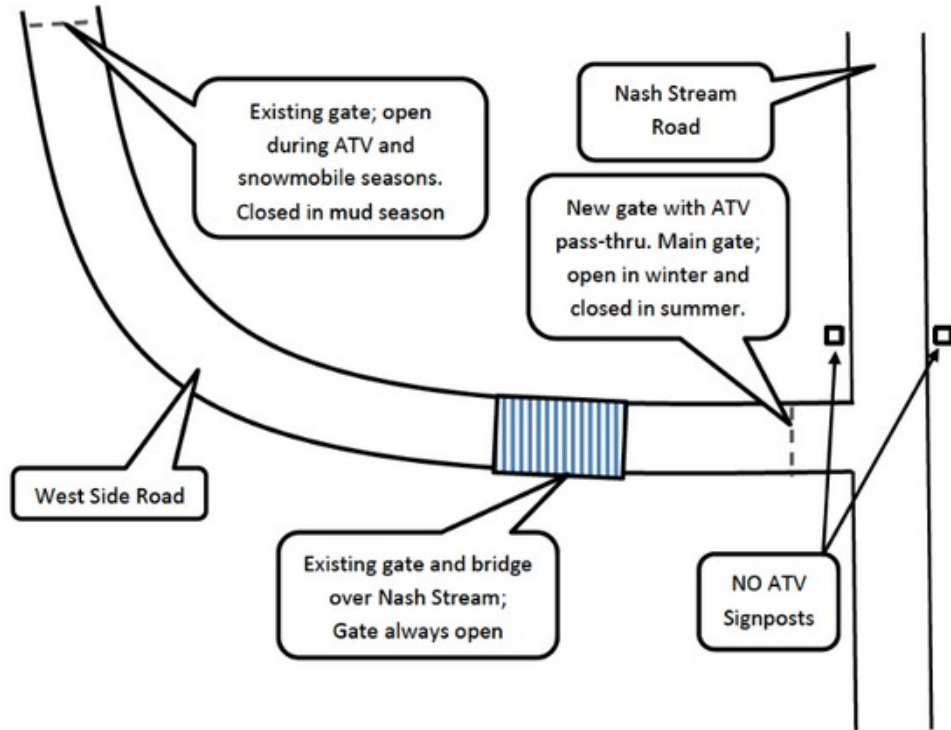

**Date:** 7/7/2018  
**Drawing:** A1 (Page 1 of 2)  
**Project:** West Side Road Gate  
**Owner:** Milan Trail Huggers  
 P.O. Box 42  
 Milan, NH 03588  
**Contact:** Larry Gomes

Proposed Southern Connector Trail – West Side Road Gate - Sample gate picture without pass-thru



In addition, the Ammonoosuc Rail Trail has several gates that require negotiation:

“Sections of the trail are badly wash boarded, enough to almost knock you off your seat. Every quarter- to half-mile there's a metal gate across most of the trail, with a narrow passage to the side. The surface of the passage is large gravel, usually combined with deep ruts.”

"There were several places where repairs were apparently made, leaving stretches of deep stone, very hard to ride through. Nearly every gate (they appeared to be new, and there are a lot of them) had stone piles around them, which were quite difficult to maneuver. You will not make great time on this trail. There was a particularly bad spot east of Lisbon that was very rough and washboarded."

<https://www.trailink.com/trail/ammonoosuc-rail-trail/>



BOT has provided gates it considers safe, for the Rockingham Recreational Rail Trail, the Rail Trail in Fitzwilliam and the Granite State Rail Trail in Londonderry:

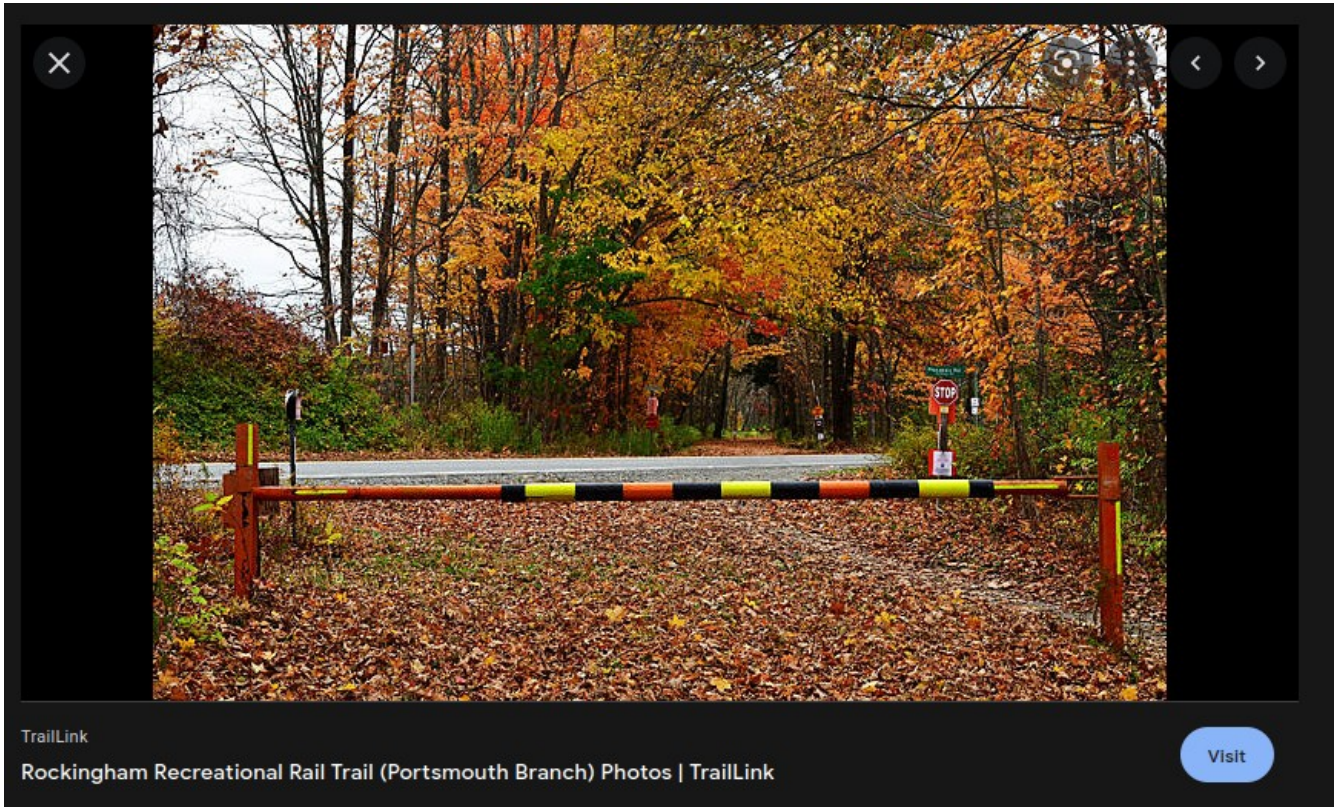

### Off Rail Trail

Fitzwilliam, NH 03447

**\$11,900**

 **12.13** Acres

 **528,383** SqFt

Listed by Kali Blais and Fred Blais of Blais & Associates, Realtors

Listing Sold by Bean Group Rindge





<https://www.barrettandvalley.com/listing/4898840/off-rail-trail-fitzwilliam-nh-03447/>

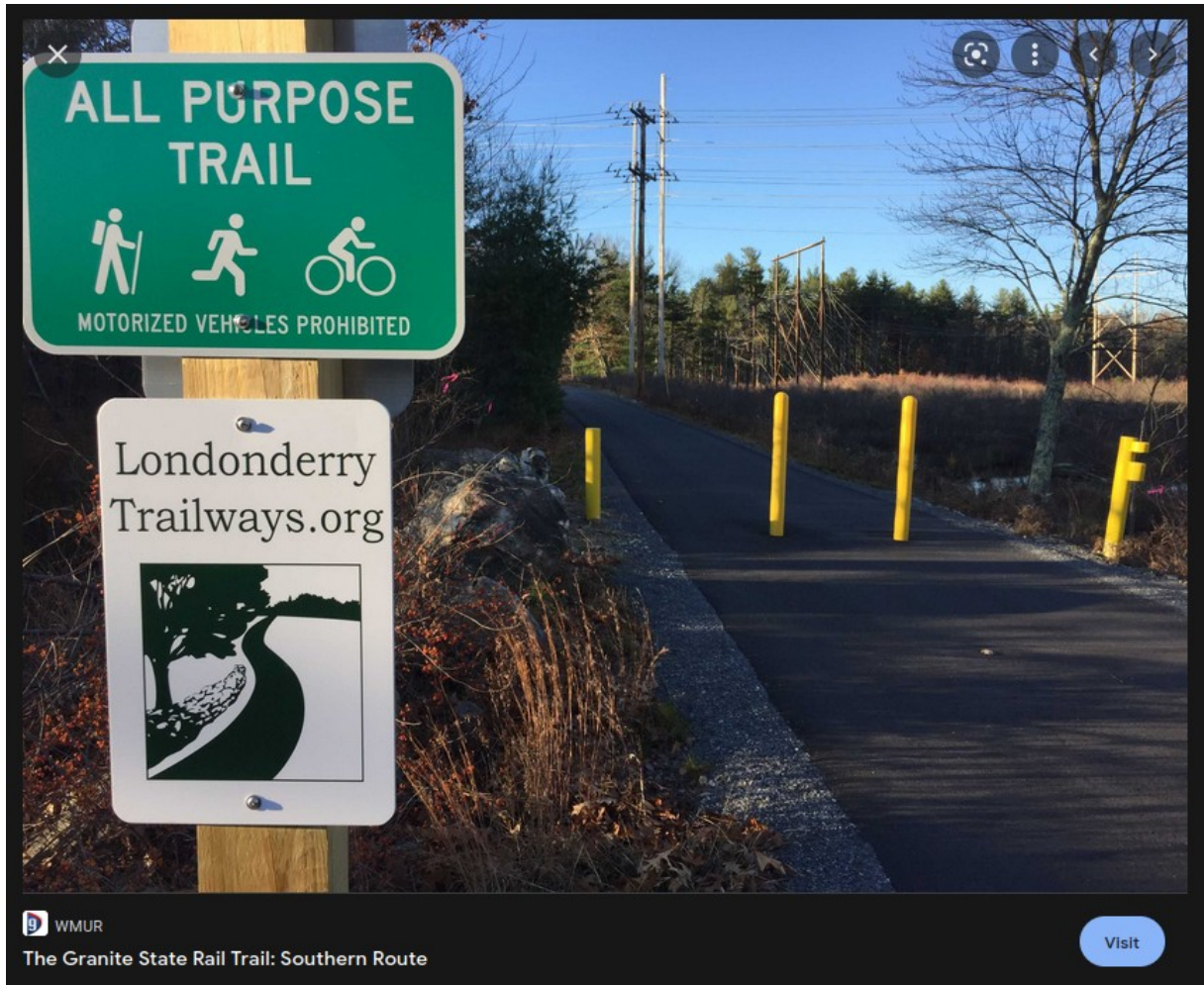

<https://www.wmur.com/article/the-granite-state-rail-trail-southern-route/8386261>

The Selectboard's test of the safety of opening Industrial Park Road to OHRVs; opening it to OHRVs and waiting to see if there are accidents, is an unethical way to assess safety.

Littleton law enforcement would perhaps express safety concerns if they fully understood the OHRV laws, the need for a constant presence to enforce them, and that they are responsible for providing this enforcement.

"You cannot operate any OHRV or snowmobile if your driver's license is under suspension or revocation in any state or Canadian province. An OHRV/Snowmobile Safety Education Certificate does not override a motor vehicle license suspension.

All operators 12 years of age or older must possess either an OHRV/Snowmobile Safety Education Certificate or a valid driver's license to operate on personal, private or public property.

Any operator under the age of 12 cannot cross roads.

Any operator under the age of 14 must be accompanied by a licensed adult at least 18 years of age.

Any operator 12 years of age or older who has successfully completed an approved OHRV/Snowmobile safety course, who is not licensed to drive must be accompanied by a licensed adult at least 25 years of age, when operating an OHRV along designated roads.

Any operator under the age of 18 cannot carry a passenger on a 3- or 4-wheel ATV. "

Kris Pastoriza

krispastoriza@gmail.com